



Massachusetts Institute of Technology

NROTC

Underwater Experiment Canister Project

MIDN 1/c Roger Cortesi, USNR (Mechanical & Ocean Engineering)

MIDN 1/c Dennis Evangelista, USNR (Mechanical & Electrical Engineering)

MIDN 2/c Nicole Justis, USNR (Material Science)

11 SEP 98

<http://web.mit.edu/uec/>

UEC Project Goals

The goal of the UEC Project is to build a small family of devices that serve as a standardized and modular method of placing secondary experiments on research submarines and submersibles. Placing additional projects on these ships is a way of accomplishing more experiments per deployment, with minimal interruption of the ship's routine.

The United States Navy's deep diving research submarine, NR-1, is serving as the platform for the project. We are also currently looking for additional platforms (Navy or civilian) that would be interested in hosting UECs onboard.



The project provides MIT Midshipmen with ocean related engineering experience.

UEC Project Background

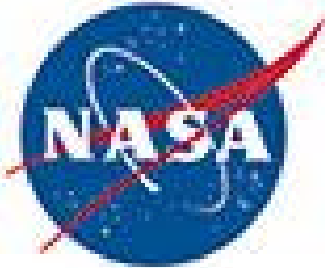

The idea for the UEC project was inspired by NASA's Small Shuttle Payloads Project (SSPP). In this program, NASA provides a family of containers in which organizations and institutions can place their experiments. These containers cover a range of sophistication levels, and are placed in the otherwise unused space of the Shuttle's cargo hold.



The UEC is the underwater version of the SSPP. It was envisioned to require no (or very little) supervision from the ship's crew. In essence the experiment would just be tagging along for the ride.



The Electric Boat Corporation's NR-1 planning office suggested that additional stand-alone experiments could be placed in NR-1's NAVNET launch tubes, if a chassis were built to allow this.

So MIT NROTC started building. But first...

What is a NAVNET?

A NAVNET is a SONAR beacon that is deployed by a submarine, allowing it to return to the beacon's location later.

NR-1 can carry up to four (4) NAVNET beacons. These are deployed from tubes at the aft end of the ship, two (2) on each side.

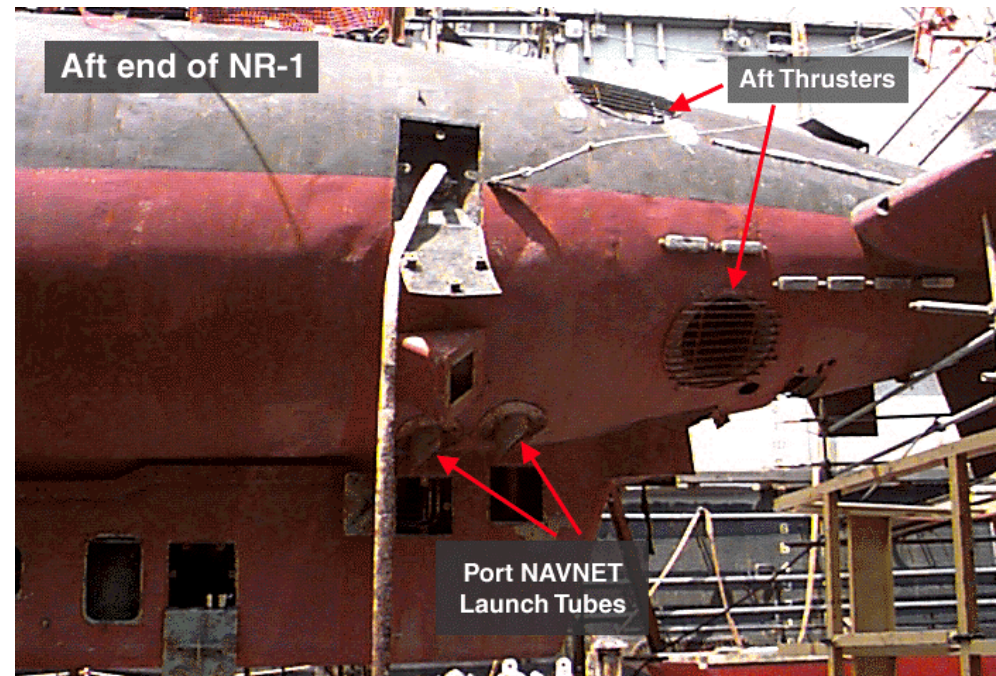
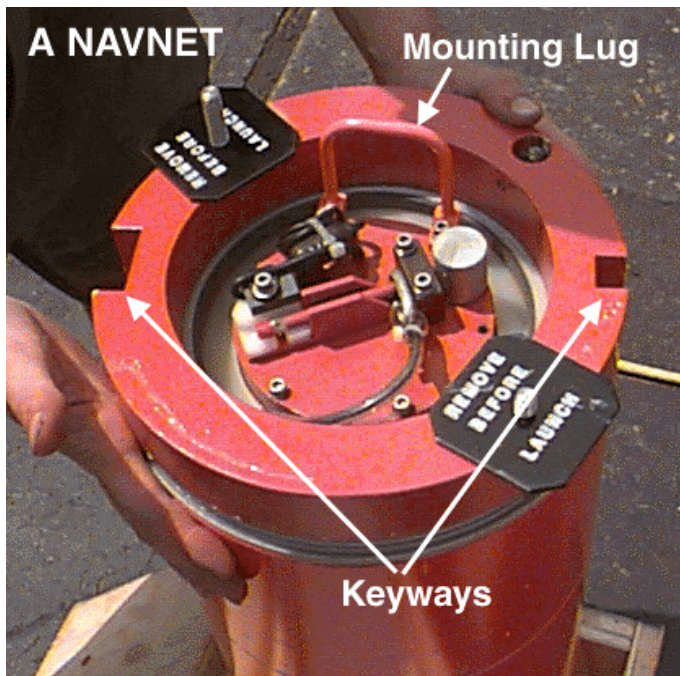

Possible UEC Versions

Four (4) types of UEC devices have been envisioned:

A Free Flooding Unit: This unit is a canister that is open to the sea and had mounting hard points on the inside. It might be good for testing materials and small components under real operating conditions.

A Split Unit: This unit has a sealed electronics bay for onboard data collection and experiment control.

A Water Sample Collection Unit: This unit is designed to take water sample at regular intervals. Time stamps, noted with each sample, can be later correlated with the navigational plot to determine the sample's location.

A Bottom Resting Unit: This unit is jettisoned by NR-1 at a specific location and rests on the bottom, running it's experiment. Upon completion it would either return to the surface or be recovered by NR-1.

Building UEC-1



UEC-1, the first UEC ever Built!

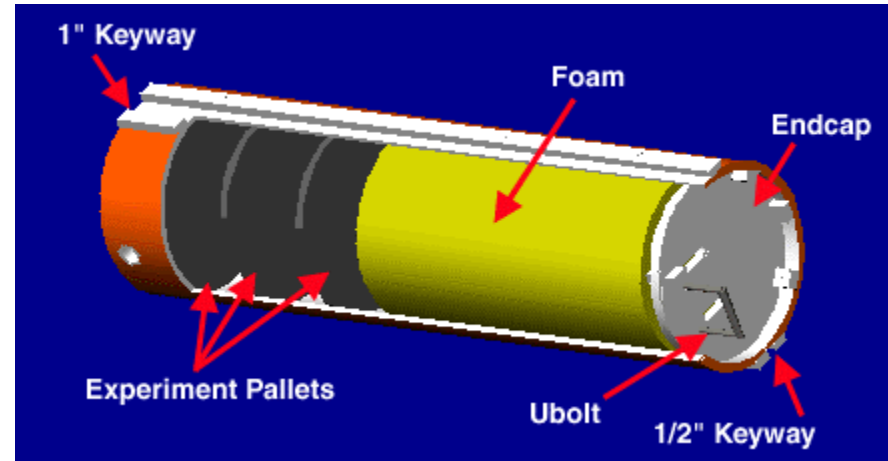

The ProEngineer model of UEC-1.

UEC-1 was built as a free flooding version.

It is the simplest of the four types described. It served as a good way of learning how to work with the submarine, and understanding the issues involved in fitting a device into the NAVNET tubes.

It was made of 8" PVC pipe. Mounting hardware was attached to the pipe.

The Mounting Bracket

The mounting bracket holds the UEC into the NAVNET tube. It went through several design iterations before the version below was selected and built.

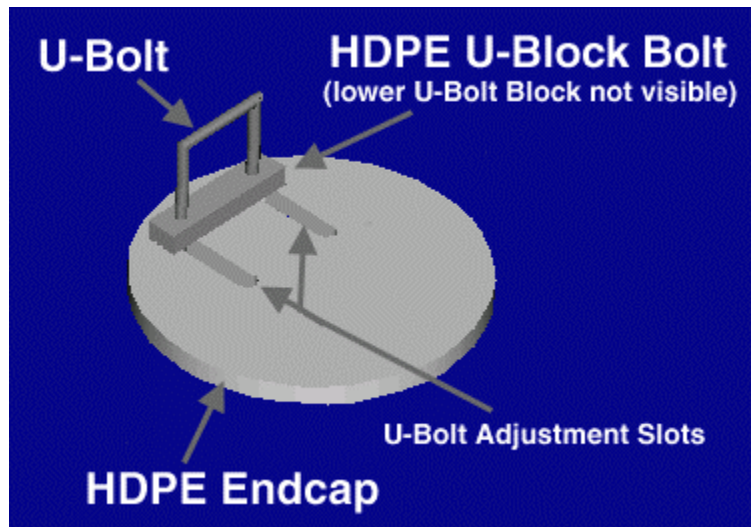

The ProEngineer model of the mounting bracket.



The finished mounting bracket on UEC-1.

The Keyways

The keyways on either side of the UEC keep it in the correct orientation in the NAVNET tube.



MIDN Cortesi measuring the clearance between the keyways in the NAVNET tubes on NR-1.

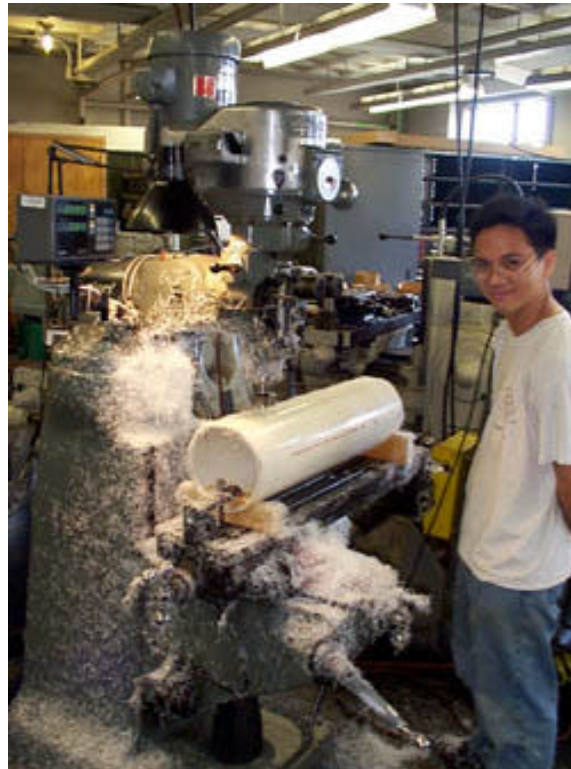

MIDN Evangelista milling the flats on the PVC UEC body.



The Finished Keyways

The Experiment Pallets



MIDN Cortesi and Marty “Waterjet God” Culpepper cut the pallets and other plastic parts on the Omax Jet Machining Center.



A finished pallet

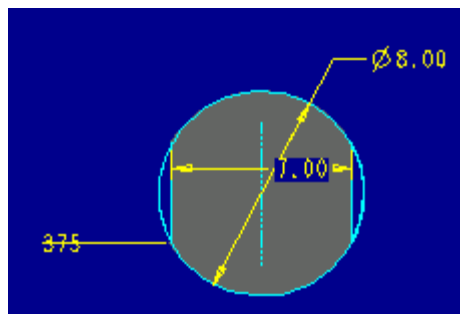

The ProEngineer model used to create the tool path for the waterjet

The UEC-1 Contains 4 experiment pallets.

Each pallet is 8” in diameter.

Pallets are stacked into the UEC with their experiments attached. Nylon Screws keep them secured.

The pallets are made of 3/8” PVC plastic.

The pallets are partial circles, this allows water to circulate freely between them when loaded.

The Syntactic Foam & Buoyancy Calculations

At this time we are still procuring the foam

The syntactic foam is composed of glass microspheres and a bonding resin.

The spheres are 3M Corporation's K37 microspheres. These have a target crush strength of 3000 psi, and density of 0.37 g/cc (23.1 lbs/ft³).

3M recommended that we start with a mixture of 40% microsphere by volume.

Assuming that the resin will have a density of approximately water (1 g/cc), the estimated overall foam density will be 0.75 g/cc (46.7 lbs/ft³).

The unloaded mass of UEC-1 (w/ 4 pallets, w/o foam) is 22.5 lbs.

The mass of the experiment payloads is approximately 4 lbs.

Half of the interior space of UEC-1 (8" dia. x 15") will be filled with foam.

There will still be -8.6 lbs of buoyancy. UEC-2 MUST BE LIGHTER

Cost of the UEC-1

Material Cost by Major Group
(per single UEC-1)

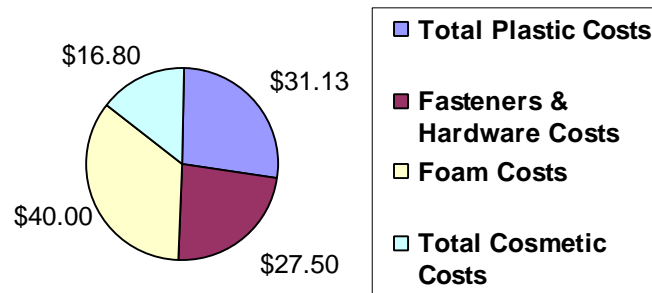

Person Hours by Major Task
(total R&D time)

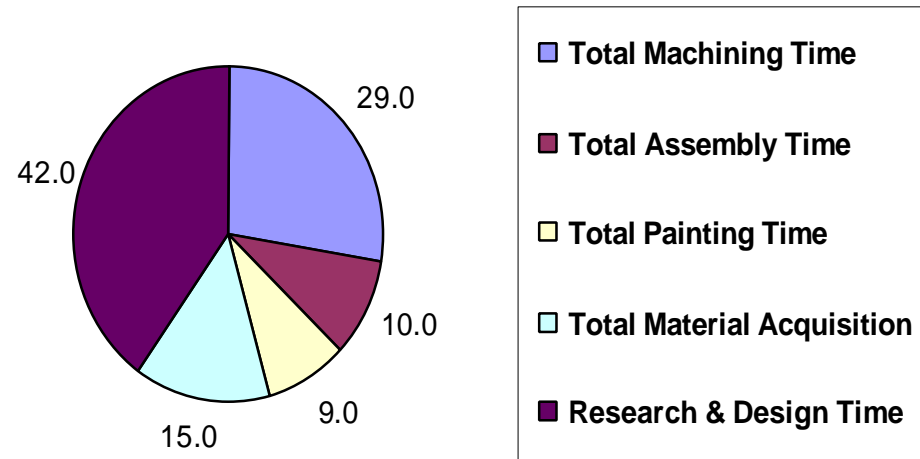

The material costs plotted above are slightly deceptive. The cost plot shows the cost of the materials actually in the UEC, not what was spent on all the materials bought for the first UEC.

Unit UEC-1 Cost: \$75.43*

Total cost of UEC-1 development to date: \$209.72*

Approximate person hours in developing UEC-1 to date: 90

* Does not include cost of syntactic foam.

Testing the First UEC



MIDN Evangelista and members of the NR-1 crew test fit UEC-1 to make sure that the mounting bracket and keyways are sized correctly.

The First Experiments

The first deployment of UEC-1 will carry the following experiments:

Strain Gage Protective Coating Experiment: This experiment will test four protective coatings' ability to protect the strain gages from the marine environment.

Electronics Potting Compound Test: This experiment will test a commercial electronics potting compound and a circuit oil bath for use in the deep marine environment

Steel Corrosion Rate Test: This experiment will compare the corrosion rate of 4340 HS Ni plated steel between the submarine's operational environment and a surface control sample.

Experiment 1: Strain Gage Protective Coatings

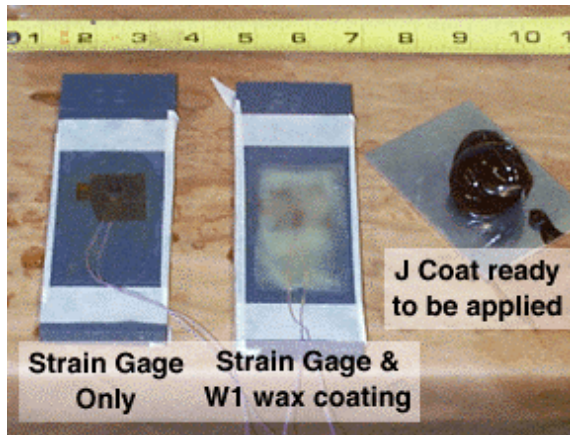

Strain gage samples in various stages of completion



MIDN Justis attaching the strain gages to the beams.

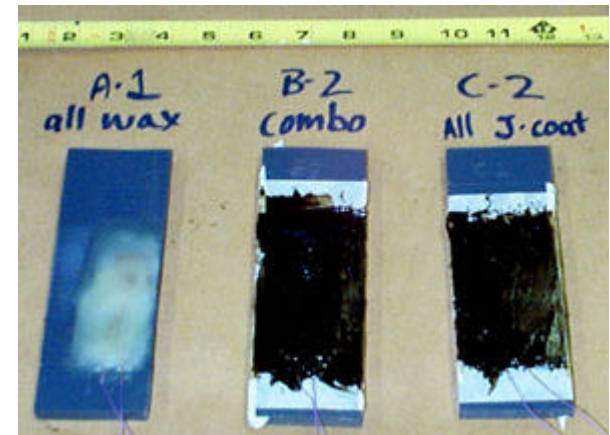

The 3 test coatings, from left to right: w1 wax only; J coat, B coat and w1 wax combination; and J coat only.

This experiment will test three (3) different coatings, alone and together, for their ability to protect the strain gages from the submarine environment.

The results from this experiment will be used to mount strain gages on future experiments. These future experiments will be testing a new piezo electric SONAR material being developed by Professor Chiang for the Undersea Warfare Center, in Newport RI.

The strain gages are mounted on PVC beams. PVC was chosen because is unaffected by the marine environment.

The Three Protective Coatings Tested

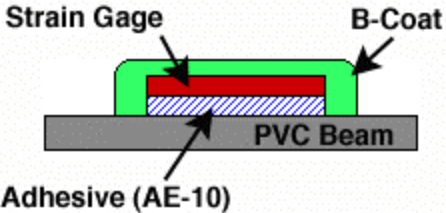
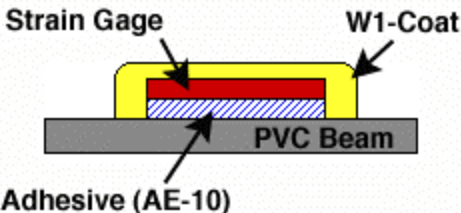
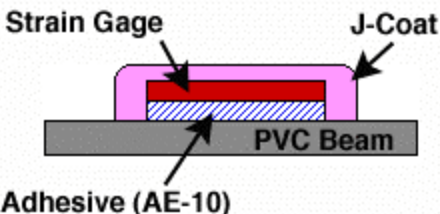
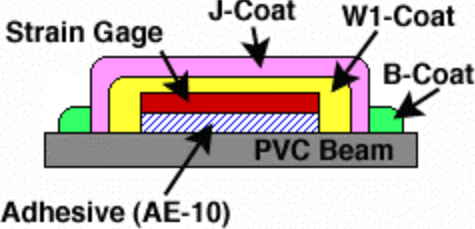
Beam #	Figure	Description
N/A		<p>B-Coat Only:</p> <p>Provides good saltwater protection and excellent adherence to bonding surface.</p>
A1		<p>W1-Coat (wax) Only:</p> <p>Provides excellent water protection, but poor mechanical protection.</p>
C2		<p>J-Coat Only:</p> <p>Provides good saltwater protection and excellent mechanical protection.</p>
B2		<p>All Coatings Layered:</p> <p>W1 provides backup water protection to J coat. J protects all coatings mechanically. B adheres coatings to PVC sample.</p>

Strain Gage Coating (continued)

The gages will be tested before UEC-1 will be deployed to make sure that they function correctly, and to collect performance data on each gage.

The gages will be connected to a Wheatstone bridge and signal generator to measure the strain. These values can be compared against the calculated stress values for the loading conditions.



MIDN Justis applying the J coating to test samples B2 and C2

Experiment 2: Electronics Potting Test

Future UEC versions and experiments will need onboard electronics. This experiment will explore two methods for packaging electronics for deep submergence. This experiment is still under preparation.

Method 1:

The Wheatstone bridge circuits (for the strain gage experiment) and a simple blinking light circuit will be potted with **Viking Products Epoxy Compound E1950**. We are particularly interested in what happens at the wire/potting compound interface. This is one of the more likely failure modes of the compound.

Method 2:

A simple blinking light circuit will be immersed in an oil bath in order to protect the electronics from the corrosive effects of seawater.

Experiment 3: 4340 HS Ni Coated Steel Corrosion Rate

4340 HS Ni coated steel is currently used in aircraft landing gear assemblies. This experiment is part of several experiments to test the steel's suitability for marine applications.

A bending moment is applied to the steel samples. One set of samples will be deployed in UEC-1, another set will be immersed in seawater in a controlled environment at MIT.

The samples will be weighed initially and a controlled scratch will be applied. The size of the scratch will be measured initially. It will be used as a reference to measure corrosion rate on the steel. The sample will be viewed with a Scanning Electron Microscope (SEM) to determine the depth of oxidation.

For quantitative analysis of degree of surface oxidation, the samples will undergo X-ray Photoelectron Spectroscopy (XPS) to determine the percentage of Fe versus FeO (rust).

4340 HS Corrosion Rate (continued)

The process of H₂ escaping and the remaining Fe²⁺ ion attaching to the O²⁻, forming FeO (rust), is corrosion.

Anodic: $\text{Fe} \Rightarrow \text{Fe}^{2+} + 2\text{e}$

Cathodic: $2\text{H}^+ + 2\text{e} \Rightarrow \text{H}_2$

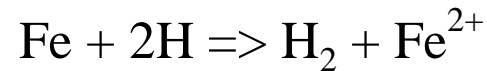

Due to the high pressure, it is more difficult for the adsorbed hydrogen to escape from the steel crystalline structure, and allow rust to form.

*The corrosion rate is expected to be less at depth than in the controlled case.

The bending moment is applied to the steel samples to impart a stress and strain on the sample.

This strain aligns the crystalline structure in the sample in one direction. This eliminates the variation in diffusion rate due to random crystal alignment.

Short Comings of UEC-1

The PVC pipe chassis of UEC-1 has several short comings:

- A large milling machine is needed to cut the flats. This is an expensive and a very time consuming operation.
- Once the flats have been cut, the pipe will distort due to the uneven wall thickness unless the inside is supported.
- It does not take full advantage of the space within the NAVNET tube.
- Access is only available through the ends of the pipe. This makes assembly and loading more difficult.
- The PVC is heavy, this decrease the usable interior volume due to the increased the amount of buoyancy required.
- Many parts and fasteners are required to attached the hardware to fit into the NAVNET tube correctly.

The Next Generation UEC

The PVC pipe will be replaced with a molded fiberglass chassis. This offers the following advantages:

- Only simple tools (bandsaw, screwdrivers, etc.) are needed to build the wooden molds.
- Once the molds are built, making more UECs will be an easier task.
- The fiberglass UEC design will be lighter than the PVC.
- The keyways and other important features can be molded into the chassis reducing the number of parts by about 25.
- The chassis will be molded in two halves, splitting the UEC down its long axis. This will make loading experiments much easier.

Other uses for the NAVNET tubes

Some SEA GRANT personnel suggested that it might be interesting to fit a AUV into the tube. So, as NR-1 is working one part of a shipwreck, the AUV could be photographing another part. The photos below shows an AUV which is no longer used, however, its dimensions (minus external batteries and motors) allow it to fit in a NAVNET tube.



The NAVNET tubes also have an unobstructed view of the bottom. A sensor package that studies the bottom could be placed there too.

Acknowledgments

- Mr. Ruditzecky, The Electric Boat NR-1 Project office
- Mr. Mayer, The Electric Boat NR-1 Project office
- The officers and crew of Submarine NR-1
- MIT Laboratory for Electromagnetic and Electronic Systems
- MIT Laboratory for Manufacturing and Productivity
- Professor Chiang, MIT Department of Material Science and Engineering
- Professor Leeb, MIT Department of Electrical Engineering
- Professor Latanision, MIT Department of Material Science and Engineering
- MIT NROTC
- RADM (Ret) Firebaugh